

# Otto 40 (420x300)+VD

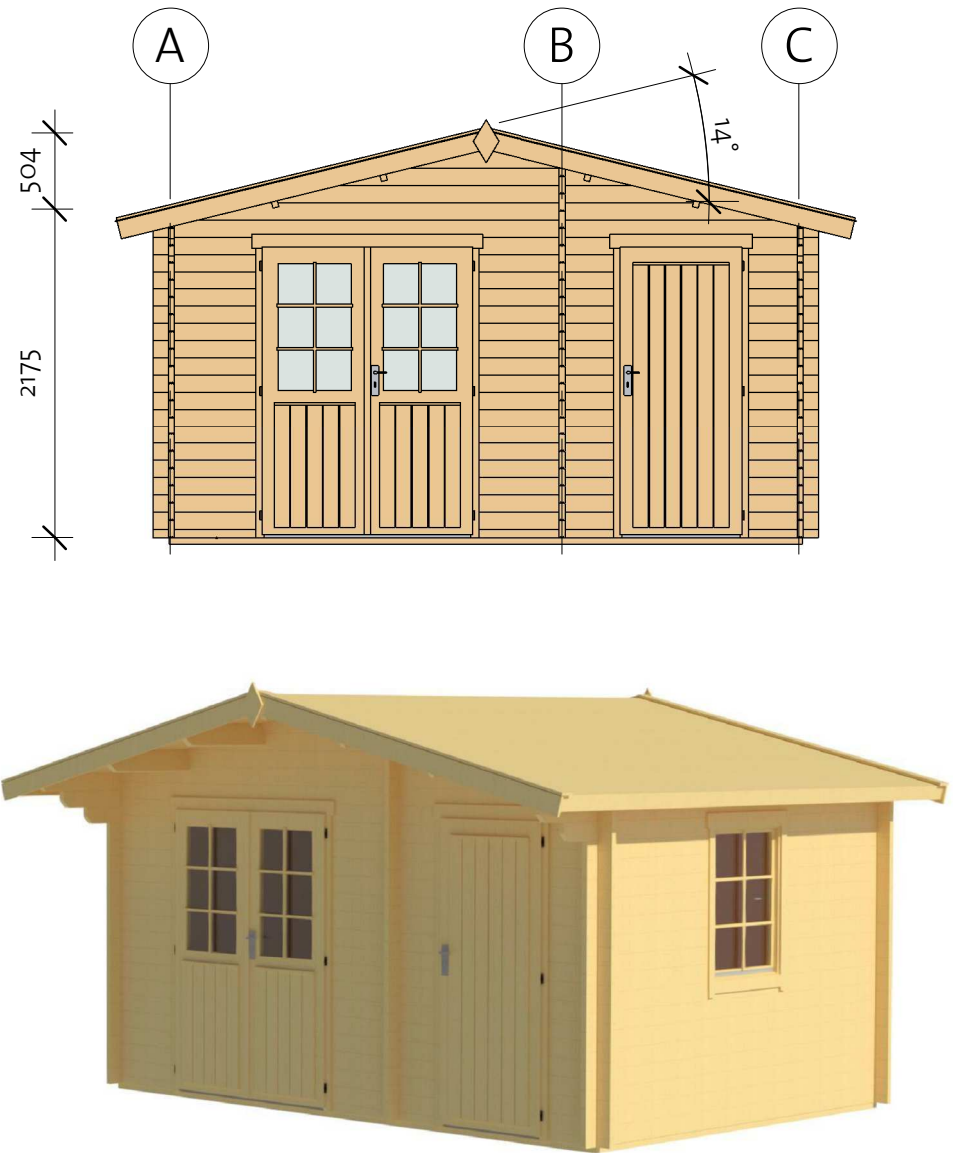

# Otto 40 (420x300)+VD

Foundation

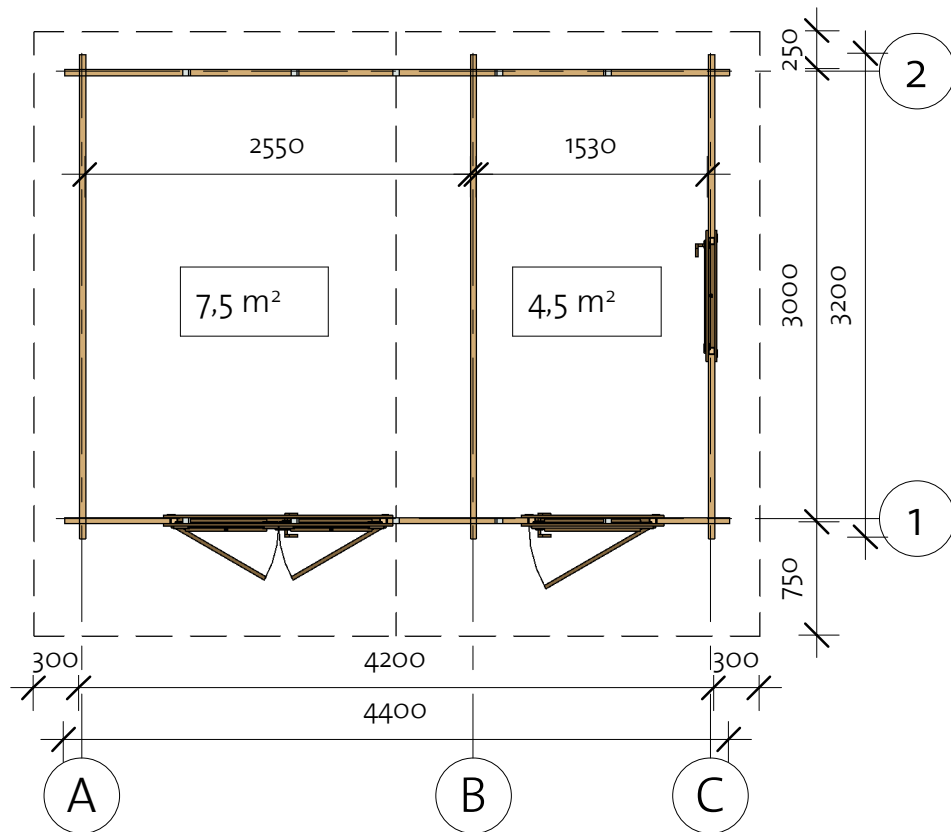
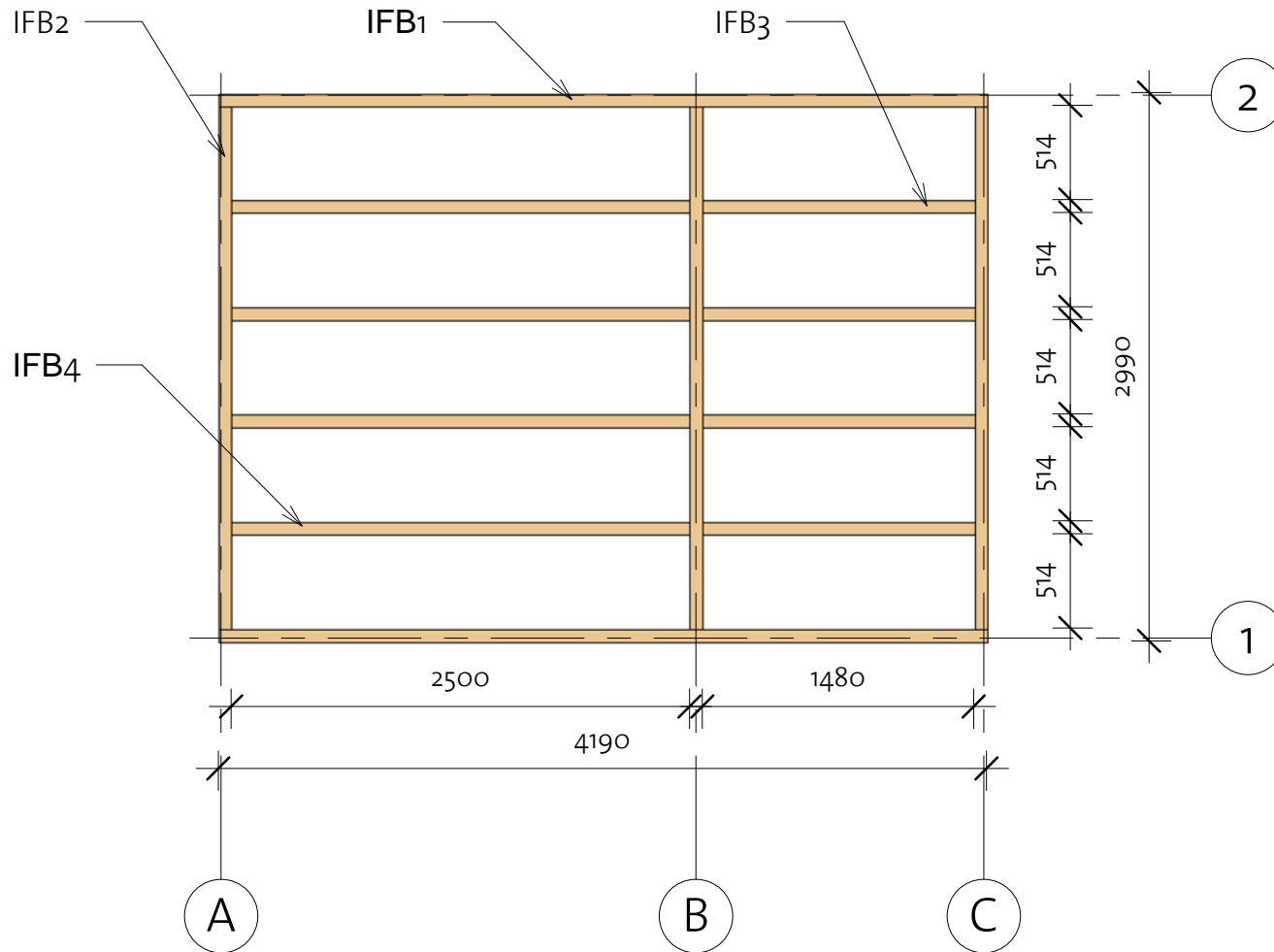

Impregnated foundation beams				
Mark	Type	Profile	Count	Length

IFB1	IFB 70x40		2	4190
IFB2	IFB 70x40		3	2850
IFB3	IFB 70x40		4	1480
IFB4	IFB 70x40		4	2500



# Otto 40 (420x300)+VD

Floor Plan

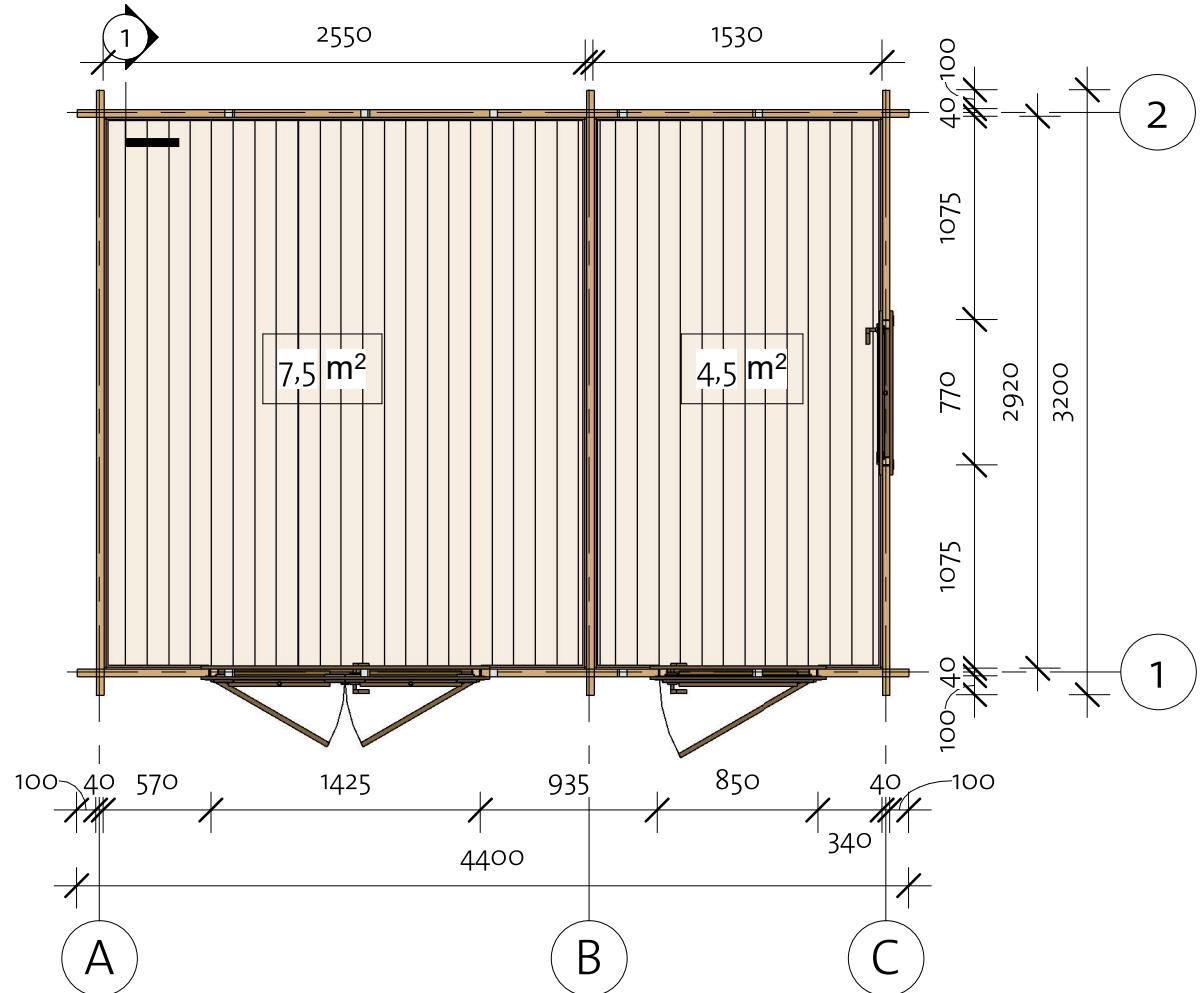
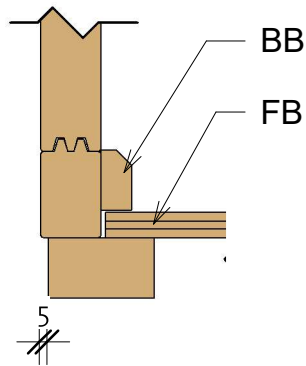
① Baseboard



Floor Schedule

Mark	Type	Profile	Count	Length
FB	FB 17x114		38	2914
BB1	BB 18x40		2	4200
BB2	BB 18x40		4	3000

# Otto 40 (420x300)+VD

Wall 1

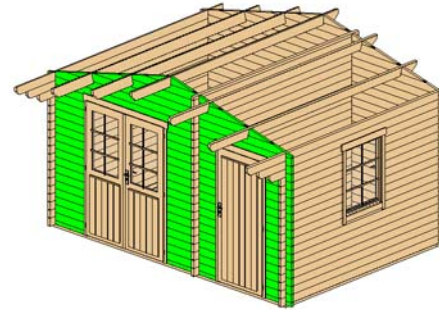

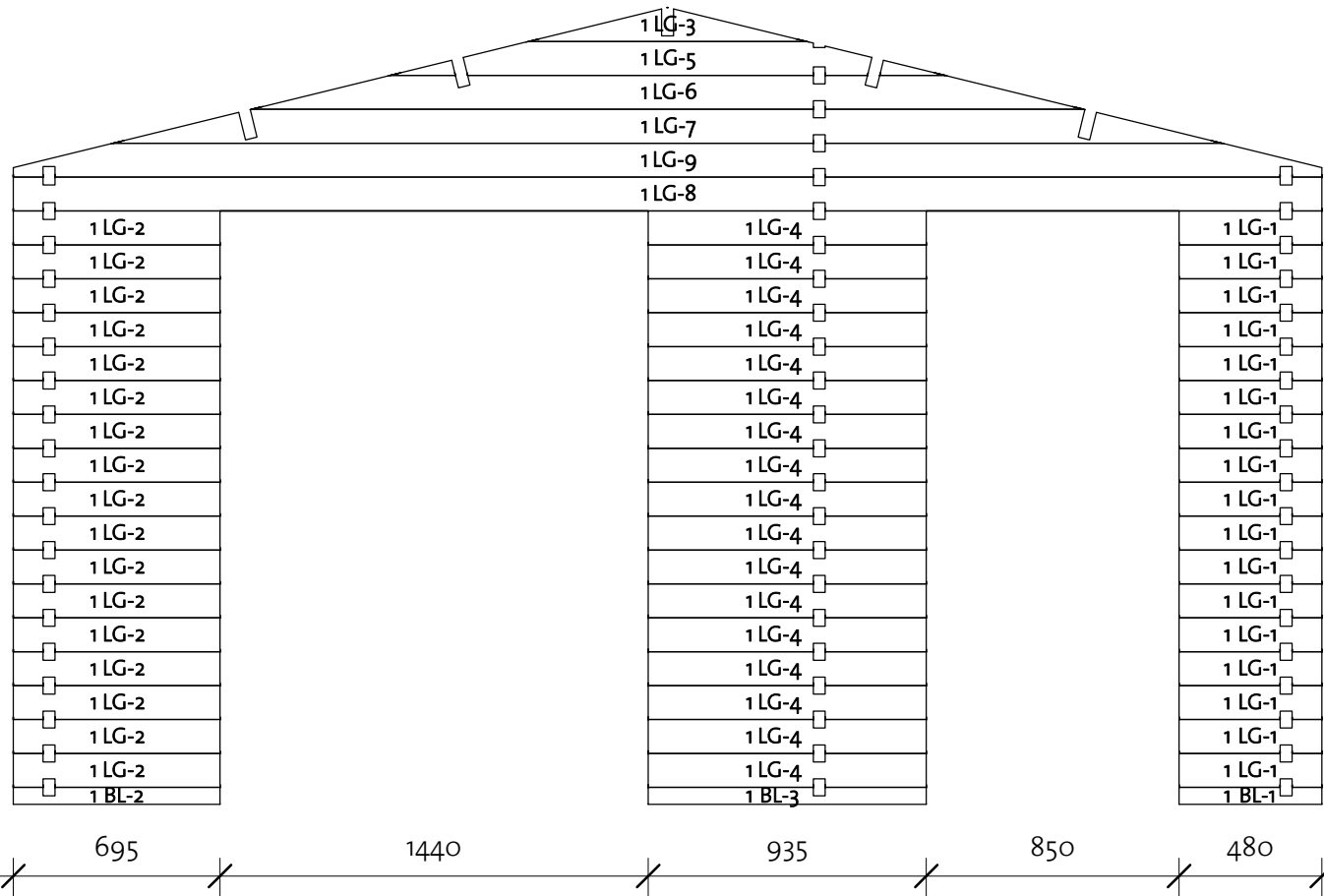

Wall 1			
Mark	Profile	Count	Cut Length

1BL-1	40x57	1	480
1BL-2	40x57	1	695
1BL-3	40x57	1	935
1LG-1	40x114	17	480
1LG-2	40x114	17	695
1LG-3	40x114	1	935
1LG-4	40x114	17	935
1LG-5	40x114	1	1866
1LG-6	40x114	1	2797
1LG-7	40x114	1	3728
1LG-8	40x114	1	4400
1LG-9	40x114	1	4400



Log Profile Wall 1	
Profile	Profile

40x57	
40x114	

# Otto 40 (420x300)+VD

Wall 2

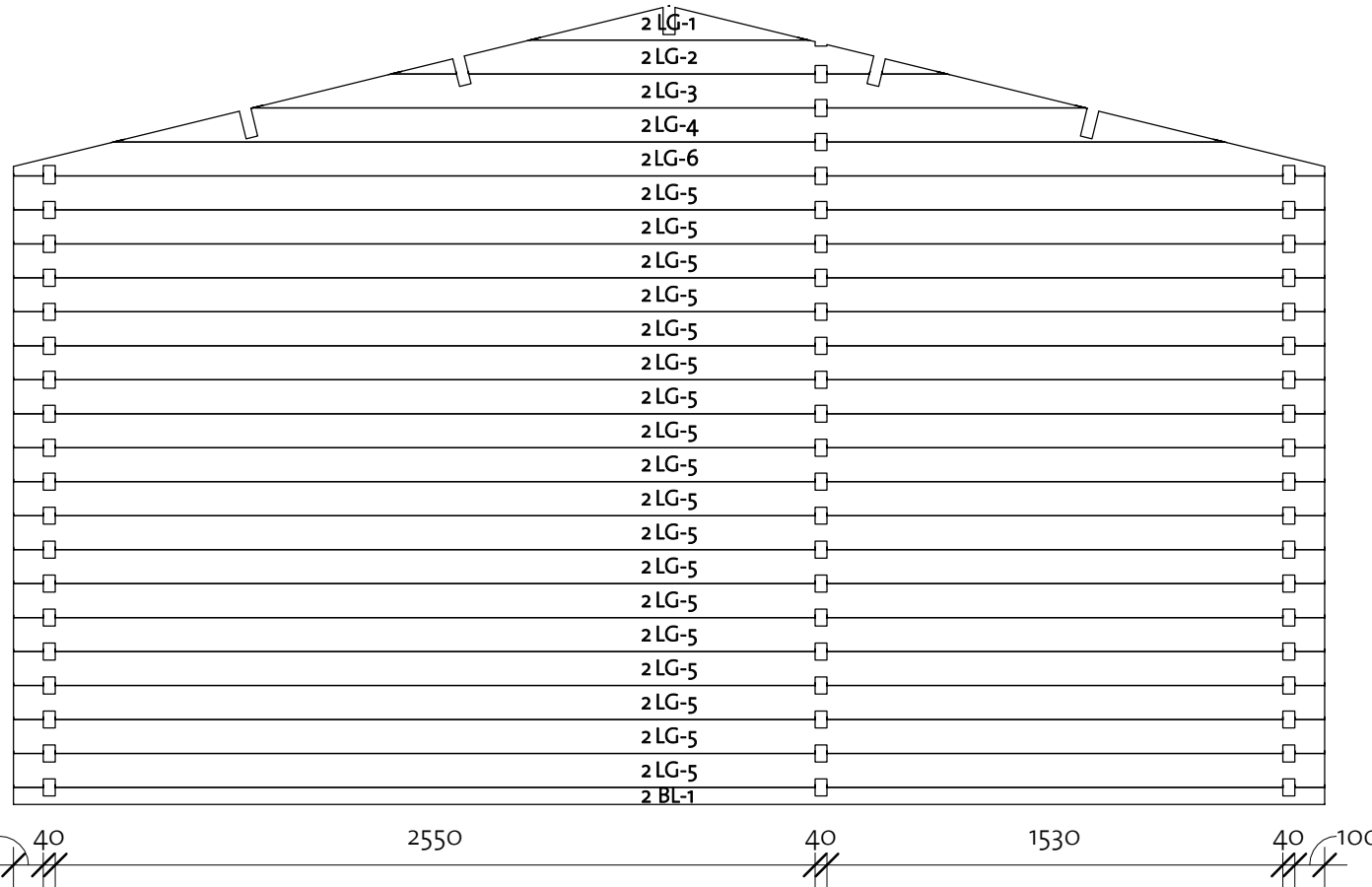
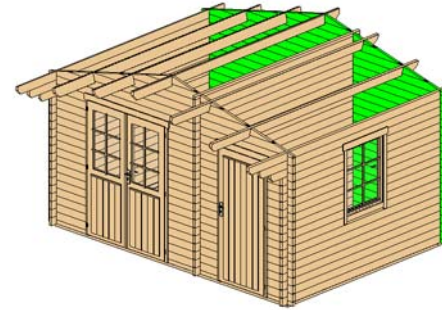

Wall 2			
Mark	Profile	Count	Cut Length

2BL-1	40X57	1	4400
2LG-1	40X114	1	935
2LG-2	40X114	1	1866
2LG-3	40X114	1	2797
2LG-4	40X114	1	3728
2LG-5	40X114	18	4400
2LG-6	40X114	1	4400

Log Profile Wall 2	
Profile	Profile

40X57	
40X114	

# Otto 40 (420x300)+VD

Wall A

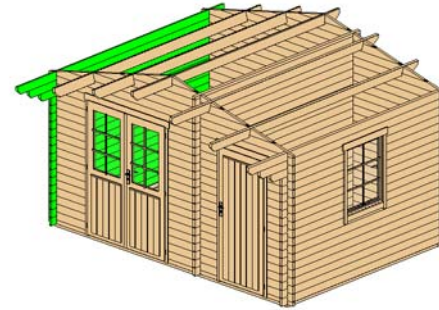

Wall A			
Mark	Profile	Count	Cut Length

ALG-1	40x114	16	3200
ALG-2	40x114	1	3416
ALG-3	40x114	1	3633
ATL-1	40x123	1	4000

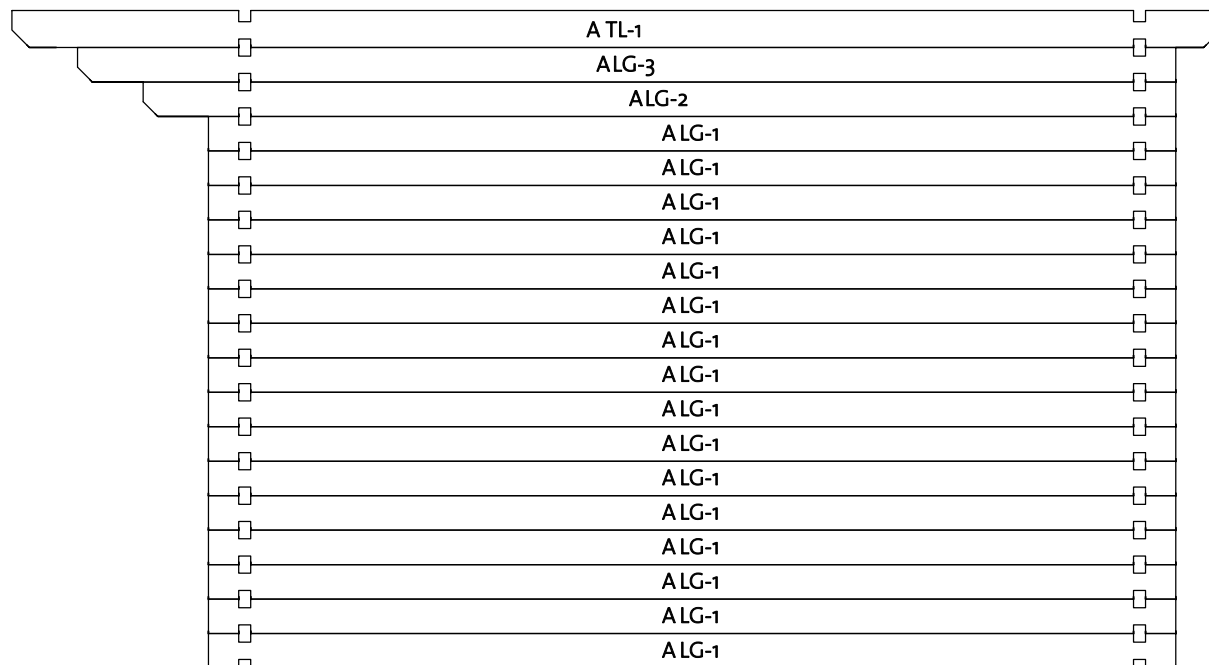

Log Profile Wall A	
Profile	Profile

40x114	
40x123	



# Otto 40 (420x300)+VD

Wall C

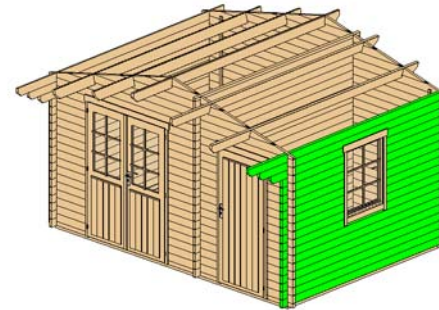

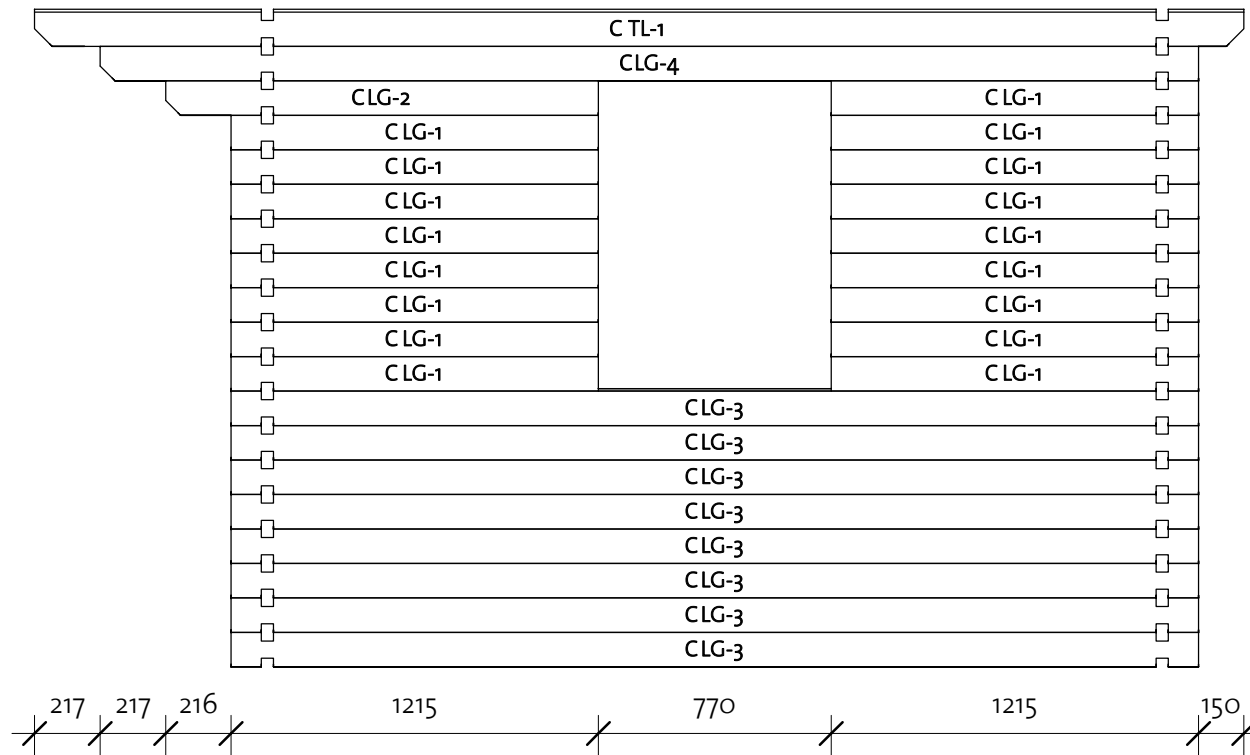

Wall C			
Mark	Profile	Count	Cut Length

CLG-1	40x114	17	1215
CLG-2	40x114	1	1431
CLG-3	40x114	8	3200
CLG-4	40x114	1	3633
CTL-1	40x123	1	4000



Log Profile Wall C	
Profile	Profile



40x114	
40x123	

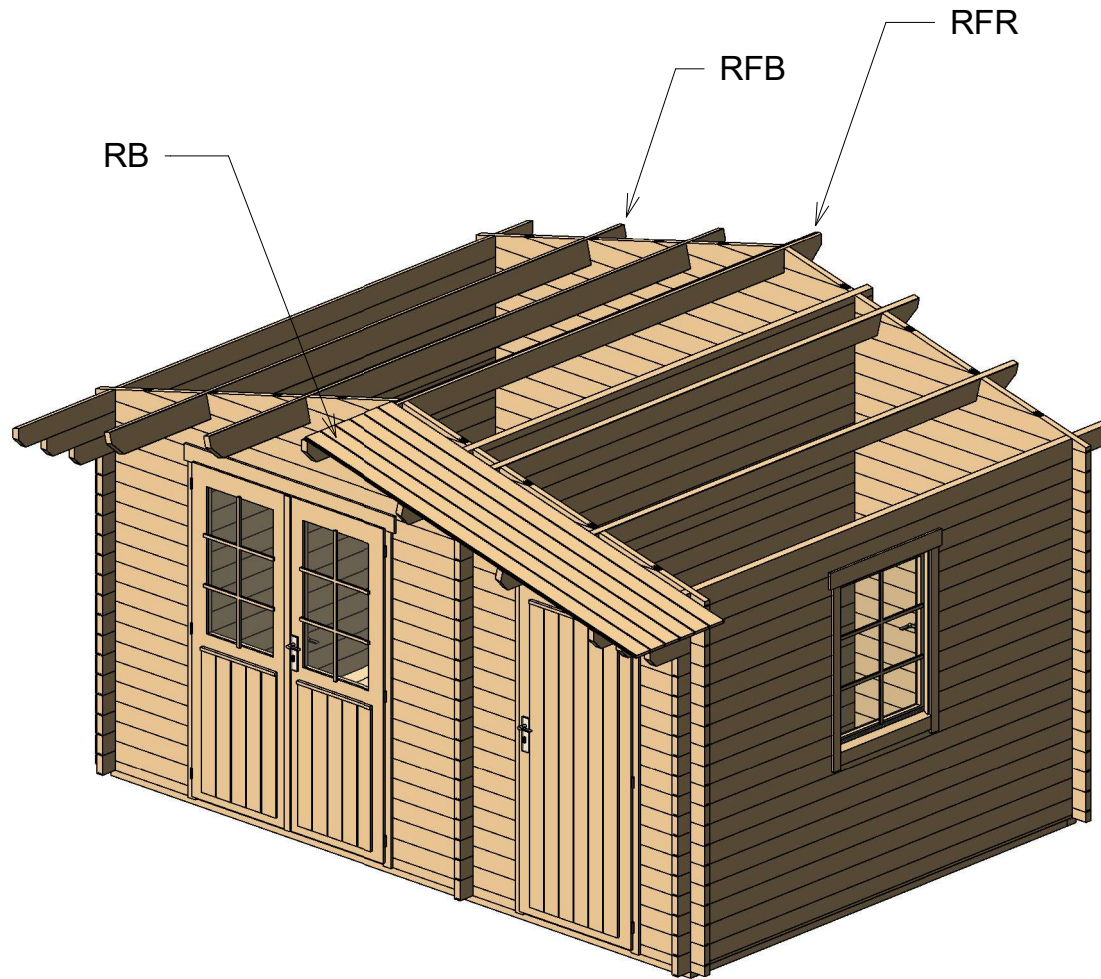

# Otto 40 (420x300)+VD

Roof 1



Roof				
Mark	Type	Profile	Count	Length
RB	17x114		72	2467
RFB	Beam 40x143		4	4000
RFR	Ridge 40x143		1	4000

# Otto 40 (420x300)+VD

Roof 2

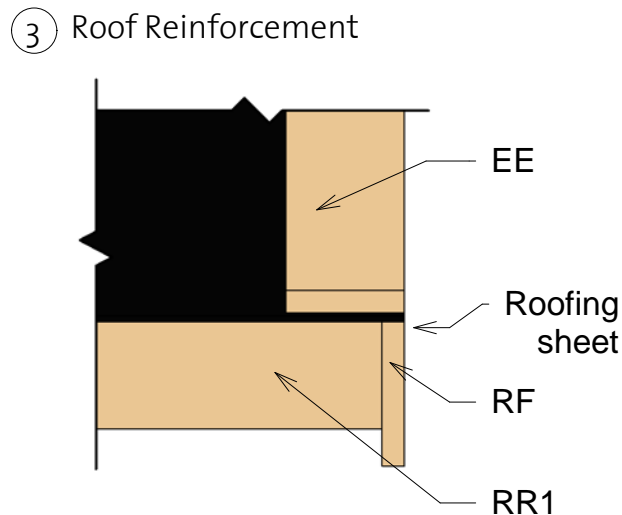
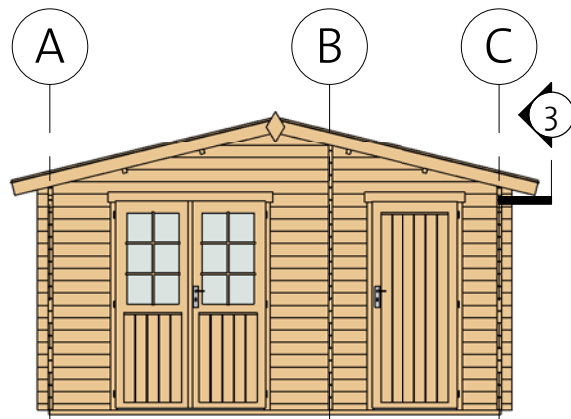
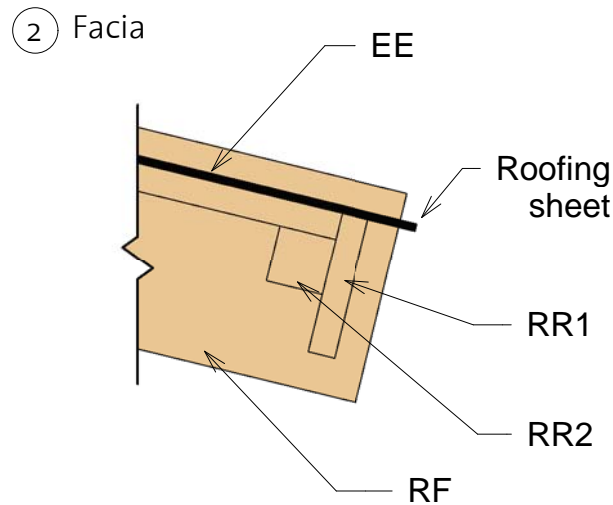
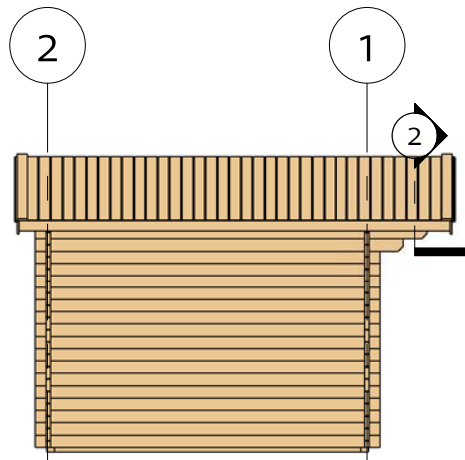

Fascia Schedule

Mark	Type	Profile	Count	Length
EE	Eave Edging 18x95		4	2510
RF	Roof Fascia 18x120		4	2510
RR1	Roof reinforcement 18x95		2	4000
RR2	Roof reinforcement 38x38		2	4000

# Otto 40 (420x300)+VD

Extras



Door Schedule				
Model	Type	Width	Height	Count
CDD1R	Classic double door 1 right	1425	1955	1
CD7R	Classic door 7, wood right	840	1955	1
DCB6	Door Crossbar 6	--	--	2

Type	Count	Length
Windboard 18x40	4	2200
Type	Count	
Romb	2	

Fasteners/Extras		
Name	Type	Count

Hitblock	300-400 mm	
Bolts	M8x70	12
Screws	5,0 x 70	15
Nails	1,4 x 40	60
Screws	6,0 x 140	65
Screws	4,0 x 40	90
Screws	4,0 x 50	570

Window Schedule				
Model	Type	Height	Width	Count
CW1R	Classic window 1 right	990	765	1
WCB6	Windows Crossbar 6	--	--	1

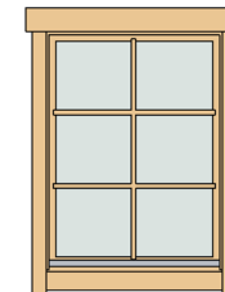



# Otto 40 (420x300)+VD

## List of all items 1



### Impregnated foundation beams

Mark	Type	Profile	Count	Length
IFB1	IFB 70x40		2	4190
IFB2	IFB 70x40		3	2850
IFB3	IFB 70x40		4	1480
IFB4	IFB 70x40		4	2500





### Floor Schedule

Mark	Type	Profile	Count	Length
FB	FB 17x114		38	2914
BB1	BB 18x40		2	4200
BB2	BB 18x40		4	3000

### Roof

Mark	Type	Profile	Count	Length
RB	17x114		72	2467
RFB	Beam 40x143		4	4000
RFR	Ridge 40x143		1	4000

### Fascia Schedule

Mark	Type	Profile	Count	Length
EE	Eave Edging 18x95		4	2510
RF	Roof Fascia 18x120		4	2510
RR1	Roof reinforc ement 18x95		2	4000
RR2	Roof reinforc ement 38x38		2	4000

# Otto 40 (420x300)+VD

## List of all items 2

Wall 1			
Mark	Profile	Count	Cut Length

1BL-1	40X57	1	480
1BL-2	40X57	1	695
1BL-3	40X57	1	935
1LG-1	40X114	17	480
1LG-2	40X114	17	695
1LG-3	40X114	1	935
1LG-4	40X114	17	935
1LG-5	40X114	1	1866
1LG-6	40X114	1	2797
1LG-7	40X114	1	3728
1LG-8	40X114	1	4400
1LG-9	40X114	1	4400

Wall 2			
Mark	Profile	Count	Cut Length

2BL-1	40X57	1	4400
2LG-1	40X114	1	935
2LG-2	40X114	1	1866
2LG-3	40X114	1	2797
2LG-4	40X114	1	3728
2LG-5	40X114	18	4400
2LG-6	40X114	1	4400

Wall A			
Mark	Profile	Count	Cut Length

ALG-1	40X114	16	3200
ALG-2	28X114	1	3416
ALG-3	28X114	1	3633
ATL-1	40X123	1	4000

Wall B			
Mark	Profile	Count	Cut Length

BLG-1	40X114	22	3200
BTL-1	40X52	1	3200

Wall C			
Mark	Profile	Count	Cut Length

CLG-1	40X114	17	1215
CLG-2	28X114	1	1431
CLG-3	40X114	8	3200
CLG-4	28X114	1	3633
CTL-1	40X123	1	4000

Log profiles	
Profile	Profile

40X57	
-------	---

Log profiles	
Profile	Profile

40X52	
-------	---

Log profiles	
Profile	Profile

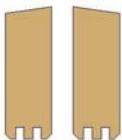
40X123	
40X114	